

# Study Effect of Adding Aluminum Sulfate as Additive for Aluminum Anodizing Process

Hameed Hussein Alwan

Babylon University / College of Engineering

Electrochemical Engineering Department

E-mail:hameed.hussein@yahoo.com

## Abstract

The aluminum anodizing is an important process and it has a wide application in industry and other important fields, the work done by applied an anodic current to Aluminum electrode immersed in 10% H<sub>2</sub>SO<sub>4</sub> solution in a constant temperature ( laboratory temperature) , the work done by study effect of two parameters on anodized layer thickness ; first one is the time (30 , 45 , and 60 ) minutes , while the second one is the effect of Aluminum ions concentration ( 0 , 0.004 , 0.006 , 0.012 , and 0.023 ) M , and this mean that the study consists effect of time and effect of Aluminum ions concentration each alone and study of interaction effect of both parameters.

## الخلاصة

ان لعملية الانودة اهمية كبيرة و لها تطبيقات واسعة في الصناعة و قد تمت عملية الانودة لقطب الالمنيوم بغمره في محلول 10% حامض الكبريتيك و في درجة حرارة ثابتة ( درجة حرارة المختبر ) و تسليط تيار انودي ثابت . و قد تم دراسة تأثير عاملين مهمين يدخلان في العملية الاول هو زمن العملية ( 30 ، 45 ، 60 ) دقيقة و العامل الثاني هو دراسة تأثير اضافة مصدر لايونات الالمنيوم الى محلول حامض الكبريتيك ( 0 ، 0.004 ، 0.006 ، 0.012 ، 0.023 ) مولاري حيث ان اضافة كبريتات الالمنيوم يؤدي الى زيادة تركيز ايونات الالمنيوم و التي بدورها تدخل في تركيب طبقة الانودة المتكونة ، ان البحث تضمن دراسة تأثير الزمن و تأثير تركيز ايونات الالمنيوم كل واحد بمعزل عن الاخر ومن ثم دراسة التأثير المتداخل للعاملين على سمك الطبقة المتكونة ، حيث ان سمك الطبقة المتكونة تتم باستخدام معادلات نظرية موثوق بها .

## Introduction

Although Aluminum anodizing has been commercialized for more 70 years, it is still a great challenge to understand the anodizing process and the influences of variables on the properties of the resultant anodic coating (Ling Hao, and *et al* 2001).

Anodizing is the formation of thick films on metal substrates , driven by an anodic potential to the metal in a suitable electrolyte .The process is important commercially for protective coatings on aluminum products but it has also niche applications for tantalum and titanium ,notable for high integrity electrolytic condensers.(Brian Ralph 1998).

When metals are exposed to a sufficiently anodic voltage in an electrochemical configuration, an oxidation reaction ( $M \rightarrow M^{+Z} + ze^{-}$ ) will be initiated, depending mainly on the electrolyte and particular anodizing parameters (P.Schmuki and *et al* 2011).

Sulfuric acid is by far the most important solution anodizing process due to the characteristics of the process (allows a wide variety of thickness) due to its permeable nature, sulfuric anodizing is excellent for clear coating (Sami A.Ajeel and *et al* 2008).

As shown above sulfuric is the more practical process, most grades aluminum and aluminum alloys can be anodized by this process, the purer the aluminum the better the anodized film .The anodizing process is the laying down or growing of a film of aluminum oxide over the surface of the aluminum .Aluminum forms a layer of the oxide very quickly, even after chemical clean, but the thickness of layer is dependent on time. Thickness of layer is dependent on time, the anodizing process accelerate denser, unbroken layer of oxide and this enhance the Aluminum properties against corrosion. Thickness layer proportional to voltage pore size is proportional to

electrolyte concentration, electrolyte concentration and applied current (J Poyner, 1991).

Coating ratio is frequently taken as a means for evaluating the effects of variables on the resultant anodic coatings. It is well known that the anodic coatings on aluminum formed in sulfuric acid electrolytes, mainly consist of both aluminum oxide and aluminum sulfate. As revealed by Mason and Fowle, 99.95% aluminum is anodized in sulfuric acid electrolyte approximately 17-20%  $Al_2(SO_4)_3$  is included in the resultant coating. Accordingly, a maximum coating ratio is approximately 2.2, despite a theoretical maximum of 1.89 providing that the coating is composed entirely of  $Al_2O_3$ . Similarly, the coating ratios of porous films vary with the content of aluminum sulfate in anodic coating as well. Because the content of aluminum sulfate in an anodic coating depends on a number of factors, such as acid concentration, temperature, current density, additives, and alloys, it is relatively hard to draw a confident conclusion on whether an additive or an operational parameter improves anodizing process on the basis of the information resulting from coating ratio measurements alone (Ling Hao and et al 2001).

The coating ratio ( $R_C$ ) is defined by the following formula (Ling Hao, and *et al* 2001).

$$R_C = \frac{W_C}{W_A}$$

$$W_C = (W_1 - W_3) / S$$

$$W_A = (W_1 - W_3) / S$$

Where,  $W_C$  and  $W_A$  in  $g / dm^2$  are net coating weight and total weight loss per unit surface area of an anodized alloy.

$W_1$  = weight of a specimen after electro polishing in gram

$W_2$  = weight of a specimen with anodic coating film in gram

$W_3$  = weight of a specimen after stripping in gram.

$S$  = surface area in  $dm^2$

It is evident that the coating ratio results from anodizing in solution contains Al ions are significantly higher than those from in solution without Al ions because the formed oxide film dissolves faster at higher temperature than at lower temperature.

The basic structure of an anodic coating is based on a series of hexagonal cells, each with a central pore and a thin barrier layer separating the electrolyte in the base of the pores from the underlying metal (Ling Hao and et al 2001).

The reactions that take place during anodizing are:

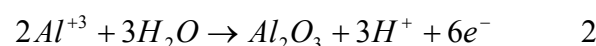

### Experimental work

The Aluminum coupon with dimensions ( $3 \times 5 \times 0.1$ ) cm used as anode in this investigation and it has the following chemical composition

Element	Mg	Mn	Ti	Fe	Cu	Al
Weight%	1.5	0.18	0.02	0.26	1.45	Balance

Sulfuric acid (10 % vol.) used as an anodizing electrolyte contains  $Al_2(SO_4)_3$  with different concentration (0, 0.004, 0.006, 0.012, and 0.023 M) the concentration values were chosen arbitrary. The aluminum also use as counter electrode (cathode).

### Materials and equipment

Phosphoric acid, Sulfuric acid, Nitric acid, Chromic acid and, Aluminum sulfate.

#### Equipment

Power supply ATTEN Model APR3002A

Hotplate stirrer, LabTech Model LMS1003

pH meter ,HANNA instrument Model HI8010

Digital Multi meter, FLUKA Model 8050A

Metallurgical Microscope provided with Camera Model AM 2011

### Experiment procedure

Aluminum sheet was cut into small specimens with dimensions  $(1.5 \times 2 \times 0.05)$  cm, and it was used as anode, also it was used as a cathode but with  $(6 \times 8 \times 0.05)$  cm.

1. The oil, grease and general dirt were removed from specimen with acetone after that it was rinsed in running water then distilled water.
2. The specimen was etched by dipping in 5% volume sodium hydroxide solution for 5 minutes at temperature of  $45^\circ C$  , the specimen was rinsed by tap water and then by distilled water .
3. Electro polishing: The specimen was polished by using the electro- polishing technique by immersion in the solution consists of: Phosphoric acid 75% ,Sulfuric acid 25% ,Nitric acid 0.1% ,The temperature of electrolyte is  $90^\circ C$  and the time immersion is 10 min and the current density is  $20 A/dm^2$  The specimen was rinsed with running water after electro polishing followed by distilled water and dried, then kept in the desiccator over a silica gel before being weighed (W1).
4. Set up anodizing cell according to apparatus shown in figure 1
5. Immersed the specimen in anodizing cell contain 10%  $H_2SO_4$  solution with required  $Al_2(SO_4)_2$  concentration , power supply was switched on a fixed current , at end of desired time (30,45 and 60 minutes) power supply was switched off , and the specimen was removed from anodizing cell. The anodizing current was adjusting at constant value  $4 A/dm^2$ .
6. Specimen was dried in drying furnace and weighed after anodizing (W2).
7. Strip the anodic film by stripping solution ( Phosphoric acid 35 ml , Chromic acid 20 g and 65 ml D.W.) rinsed specimen by water followed by D.W. and dried and weighed (W3).

The anodic film thickness calculated by below equation:

$$T = \frac{(W_2 - W_3) \times 10^4}{S\rho}$$

Where

T= coating thickness in micron

W2 = weight of a specimen with anodic coating film in gram

W3 = weight of a specimen after stripping in gram.

S = surface area in  $dm^2$ .

$\rho$  = density in  $g/cm^3$ .

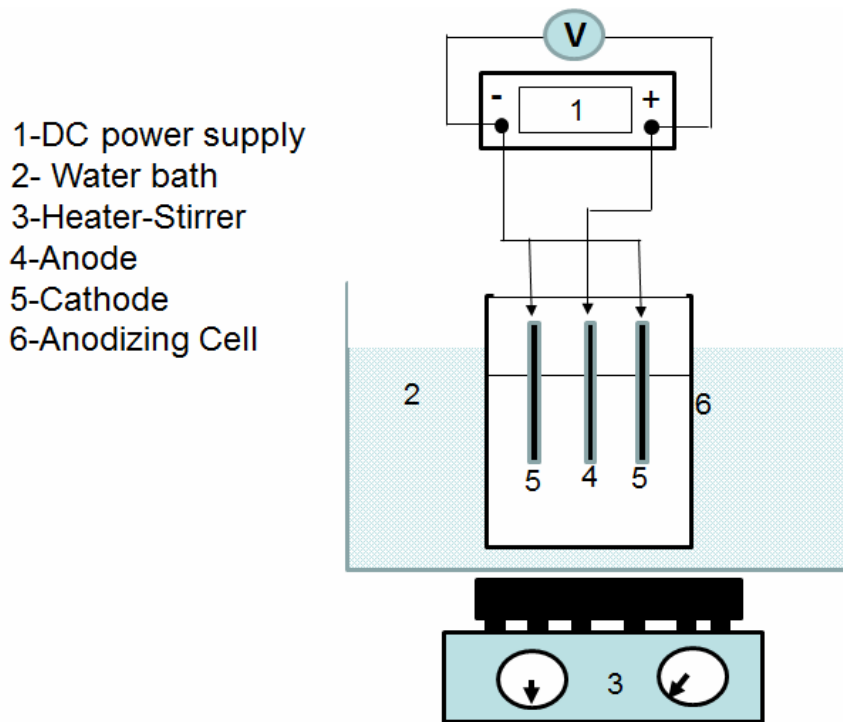

Figure 1 anodizing cell apparatus

### Result and discussions

The result that got by the experiments which done for different condition:  $Al_2(SO_4)_3$  with different concentration ( 0, 0.004,0.006,0.012 , and 0.023 M) in 10 % sulfuric acid solution ,and, operation time (30, 45, 60 minutes) .are listed in the below table

Time Minutes	$Al_2(SO_4)_3$ Concentration (M)	W1 gram	W2 gram	W3 gram	T micron	$W_A$ g/dm <sup>2</sup>	$W_C$ g/dm <sup>2</sup>	$R_C$
30	0	0.7527	0.7855	0.7759	533.3	0.128	0.437	0.293
30	0.004	0.7711	0.7656	0.758	703.7	0.169	0.291	0.580
30	0.006	0.7943	0.7884	0.7807	713.0	0.171	0.302	0.566
30	0.012	0.7237	0.697	0.6859	616.7	0.148	0.504	0.294
30	0.023	0.8286	0.8017	0.7971	255.6	0.061	0.420	0.146
45	0	0.7478	0.7	0.698	111.1	0.027	0.664	0.040
45	0.004	0.897	0.8506	0.8461	250.0	0.060	0.679	0.088
45	0.006	0.7209	0.6896	0.6824	400.0	0.096	0.513	0.187
45	0.012	0.8072	0.7615	0.756	509.3	0.122	1.138	0.107
45	0.023	0.9362	0.8885	0.8816	638.9	0.153	1.213	0.126
60	0	0.7796	0.7601	0.7569	296.3	0.071	0.504	0.141
60	0.004	0.9038	0.8401	0.8363	211.1	0.051	0.900	0.056
60	0.006	0.7429	0.687	0.682	277.8	0.067	0.812	0.082
60	0.012	0.9059	0.8842	0.8796	425.9	0.102	0.584	0.175
60	0.023	0.8876	0.8269	0.819	731.5	0.176	1.524	0.115

It is clear from the above result effect of adding Aluminum sulfate and this agree with Mason and Fowle (2001), the content of aluminum sulfate in anodic coating depends on number of factors, such as acid concentration, temperature, current density, additive and alloys

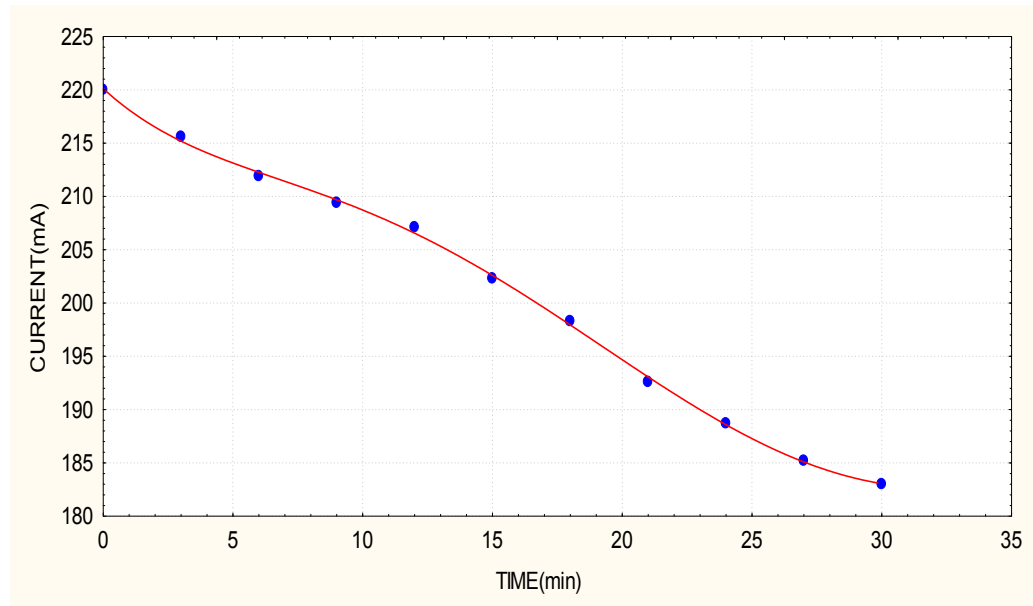

Figure 2 show the measured current with time during anodizing process by electrolyte contain 0.006 M  $Al_2(SO_4)_3$  and this good indicator for increasing the electrical resistance due to oxide film formation.

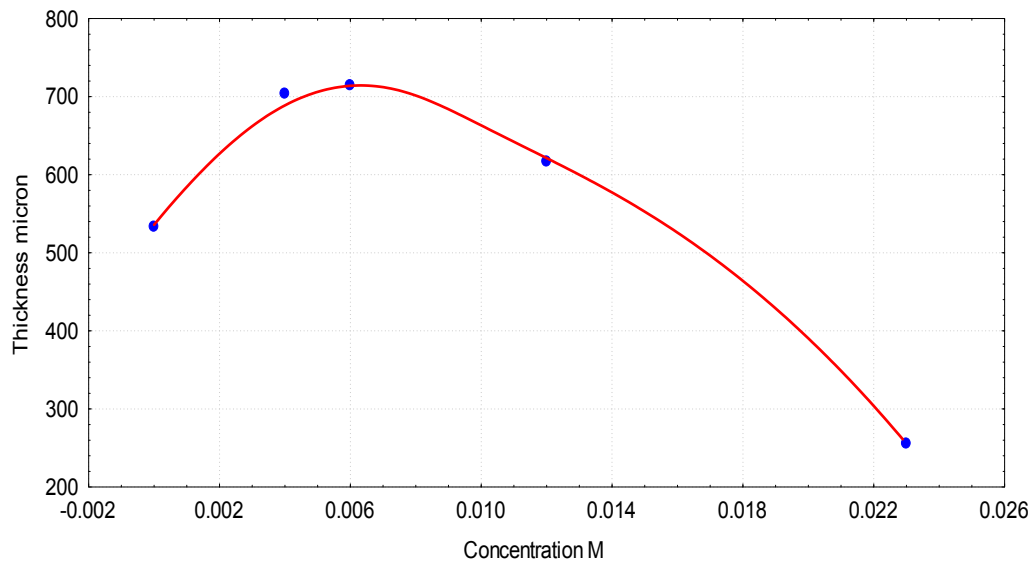

Figure 3 show the thickness as a function  $Al_2(SO_4)_3$  concentration at constant time 30 minutes

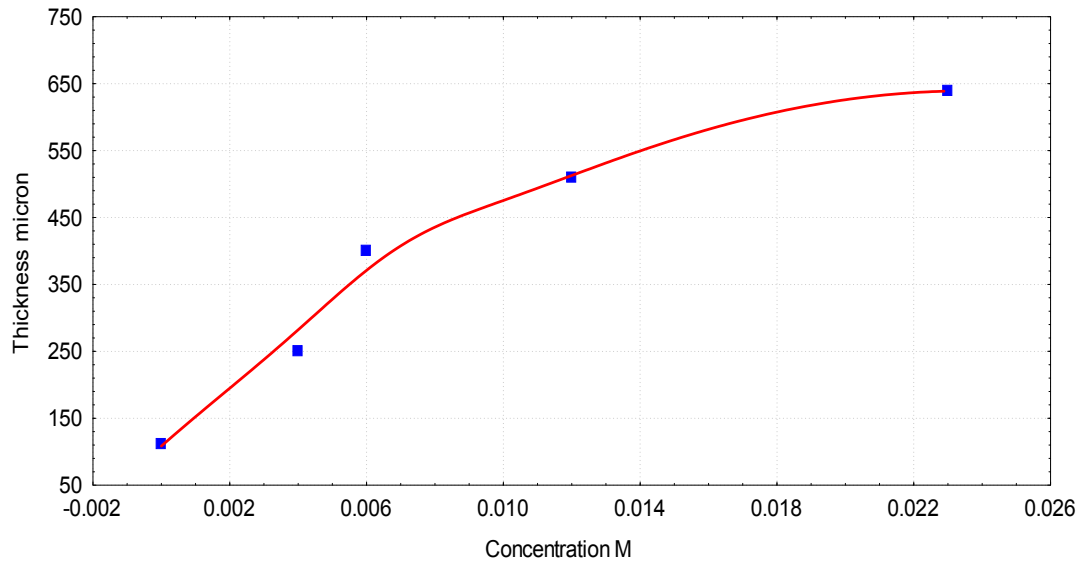

Figure 4 show the thickness as a function  $\text{Al}_2(\text{SO}_4)_3$  concentration at constant time 45 minutes

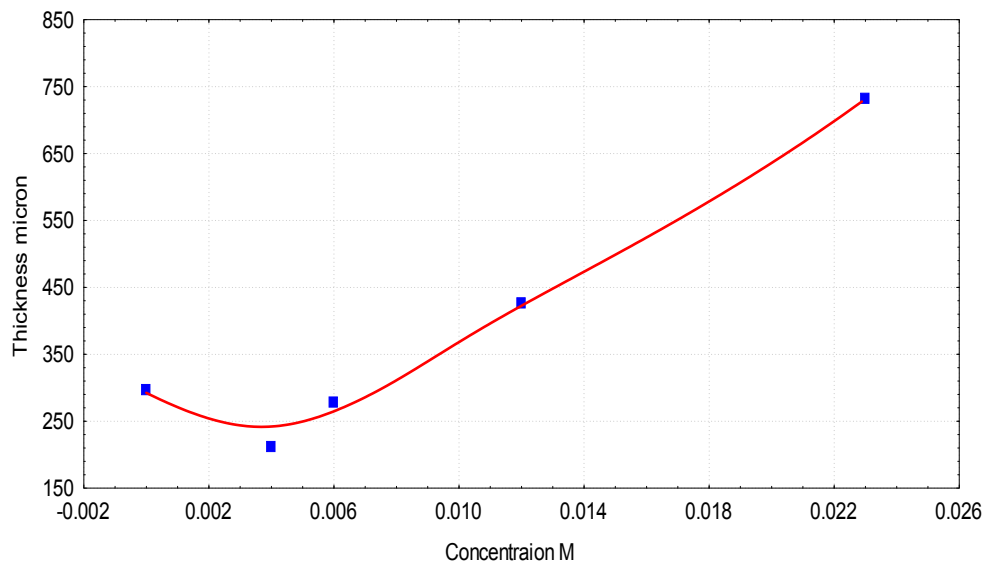

Figure 5 show the thickness as a function  $\text{Al}_2(\text{SO}_4)_3$  concentration at constant time 60 minutes

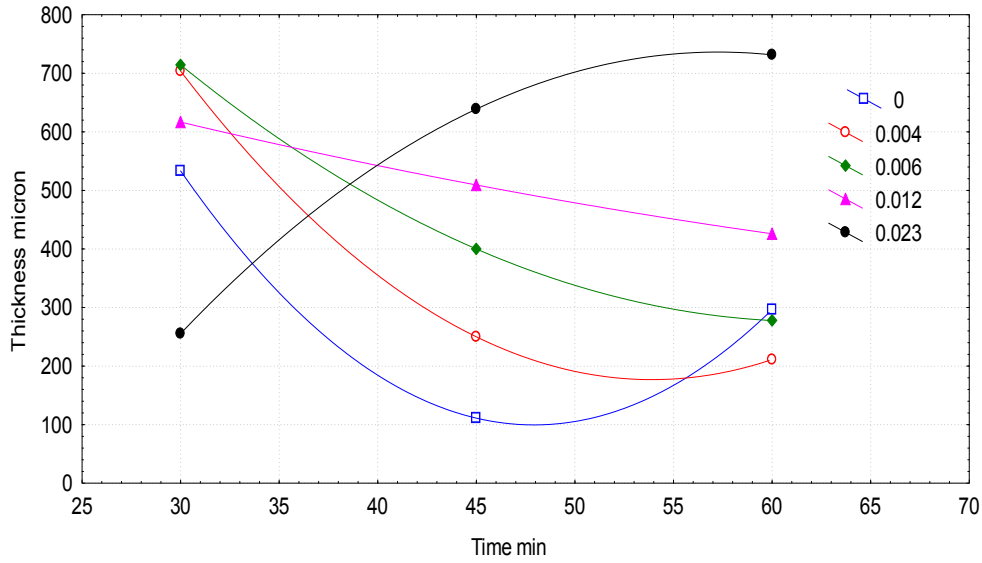

Figure 6 show the interaction effect of time and concentration of  $Al_2(SO_4)_2$  on anodizing process.

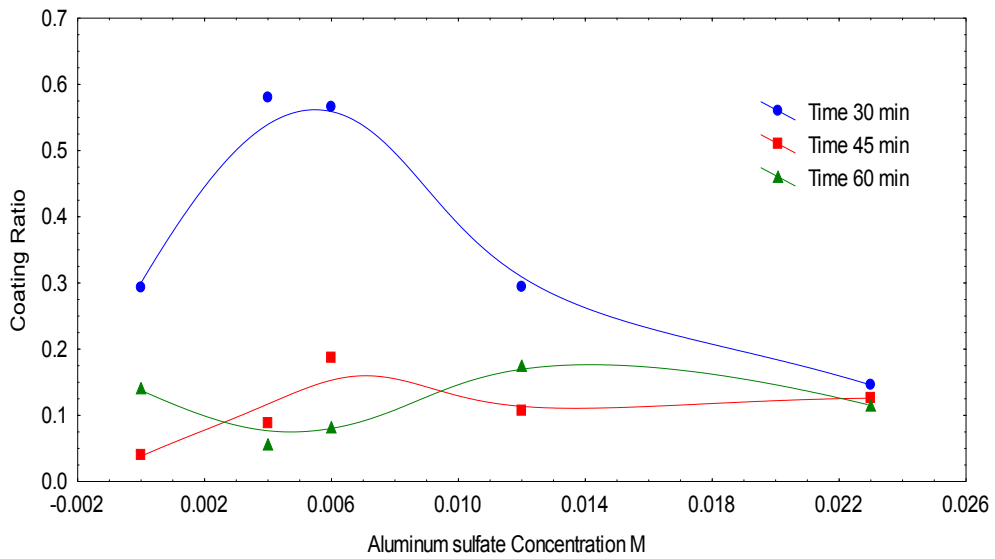

Figure 7 show the effect of  $Al_2(SO_4)_2$  concentration on coating ratio

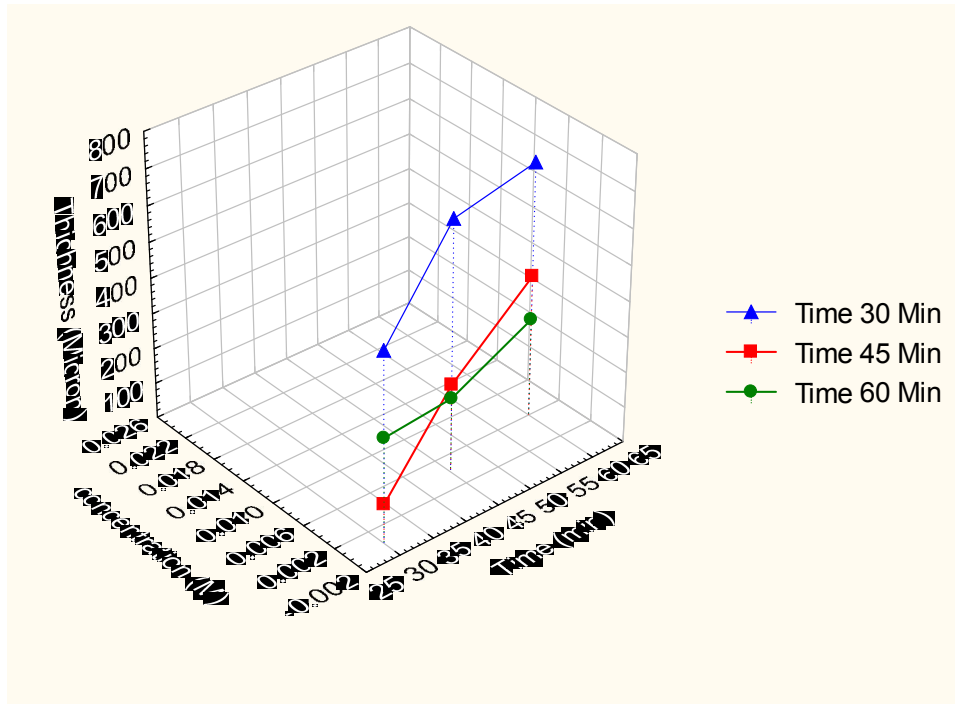

Figure 8 show interaction effect of  $Al_2(SO_4)_3$  concentrations with time anodic coating thickness by use 3D plot technique.

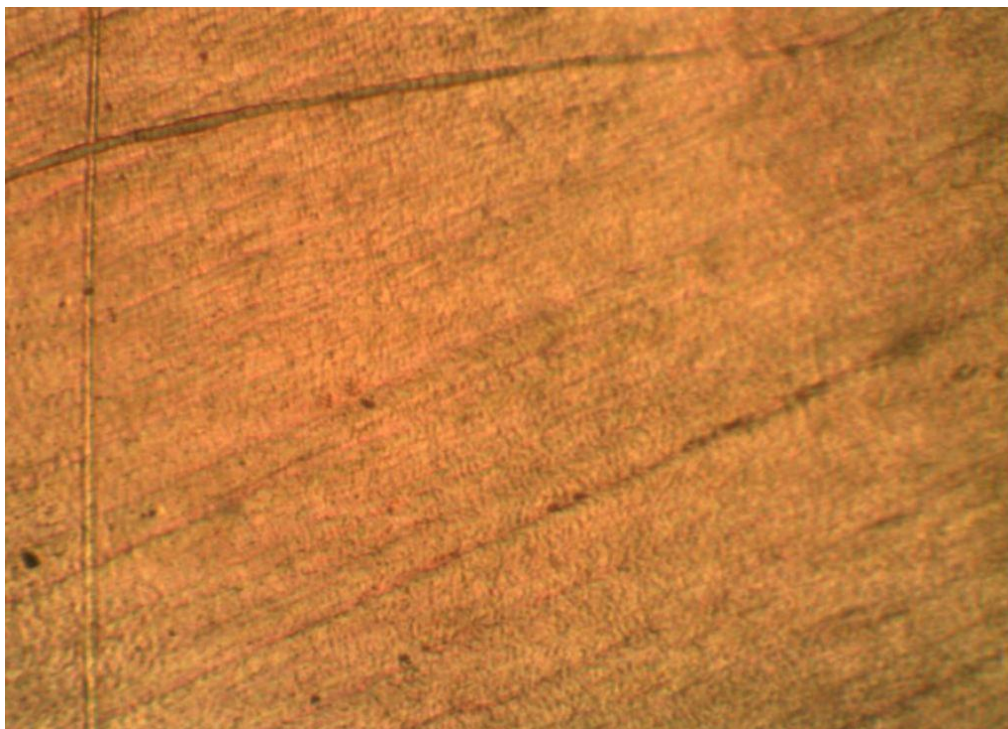
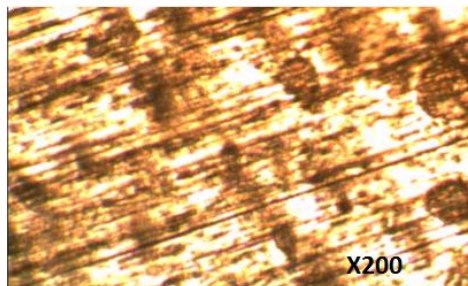
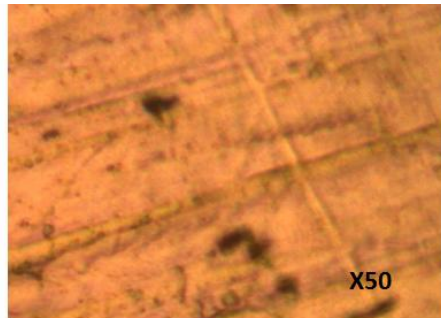
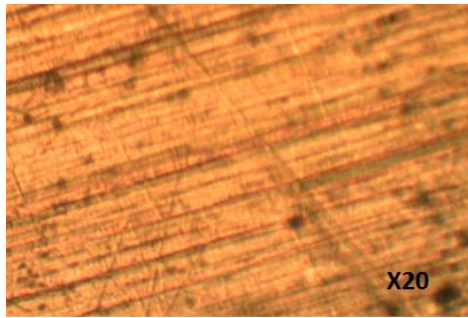

Figure 9 show the aluminum electrode after electro polishing photo with X 50





The photo show the of electrode Anodized in 10 % sulfuric acid solution contain 0.004 M , the anodizing time is 30 minutes

Figure 10

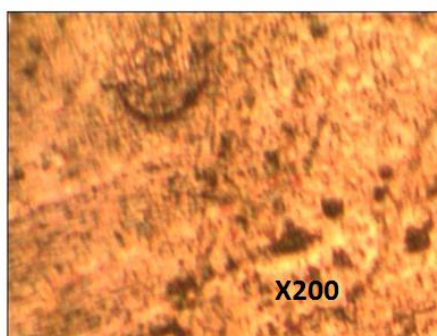
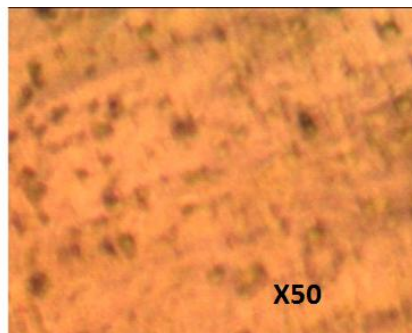
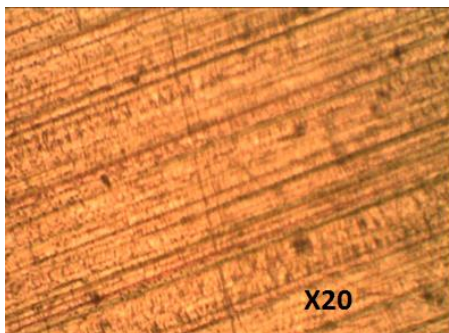

The photo show the of electrode Anodized in 10 % sulfuric acid solution contain 0.012 M , the anodizing time is 60 minutes

Figure 11

## Conclusion

The effect of aluminum sulfate concentration on anodized layer thickness can be shown on figure 3, 4 and, 5 it is clear that the increasing of Aluminum ions concentration lead to thickness of anodized layer increasing ,and this because of  $Al_2(SO_4)_3$  present can be electrolysis according to the reaction

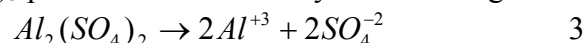

The presence of hydrogen ions according to equation 2, can be react with sulfate ions and this lead to formation of sulfuric acid , so the acidity solution increasing which increase the total weight loss per unit surface area and this means the coating ratio is small with high concentration and time.

Figures 6 and 7, show the interaction of time and Aluminum ions concentration effect on anodized layer thickness the curves shown clearly the thickness increasing with Aluminum ions concentration is not continue and this because of acidity increasing during the process.

## References

- Brian Ralph , Corrosion Science and Technology , CRC press , USA, 1998.
- J. Poyner, Electroplating, Workshop Practice Series, Argus Books, UK, 1991.
- Ling Hao Tami Westre and B. Rachel Cheng, A Comparative Study of Current Conversion Efficiency of the METALAST Anodizing Processes with and without METALAST additive, METALAST technical report, 2001.
- P.Schmuki et al., TiO<sub>2</sub> Nanotubes Synthesis and applications, Angew. Chem. Int. Ed, 2011, Vol. 50, pp2904-2939.
- S.G. Byeon and Y. Tzeng , Improved Oxide Properties by Anodization of Aluminum Films with Thin Sputtered Aluminum Oxide Overlays, J. Electrochem. Soc. Vol. 135 , No. 10.
- Sami A. Ajeel , and uday Sami Muhammad , Improving Anodizing Efficiency by Adding Different Amounts of Aluminum Powder to Anodizing Electrolyte for Pure Aluiminum and Aluminum Alloy (6063) . Eng. & Tech.2008, Vol. 26, No. 26 ,pp 842.
- Sami A. Ajeel and Uday Sami Muhammad , The Determination of Optimum Conditions for Anodizing Aluminum Alloy, Eng. & Tech. ,2008, Vol. 25 ,pp1341 .

<http://electrochem.cwru.edu/encycl/art-a02-anodizing.htm>

<http://www.finishing.com/158/62.shtml>

<http://www.surfacetechique.com/metal-plating-services/metal-anodizing.htm>